



ARR-648GR

Shown with 4" Riser (optional).
Hand polished stainless steel finish.

RANGE TOP FEATURES

- Sealed burners deliver exceptional performance at every setting and lift off to provide easy cleanup.
- 3 sizes of burners to serve your everyday needs:
17,000 BTU (lg), 13,000 BTU (med), 9,000 BTU (sm)
- Variable infinite flame settings for all sealed top burners.
- Automatic, electronic ignition ensures re-ignition in the event the flame goes out, even on the lowest burner setting.
- Continuous commercial-grade cast iron grates allow for easy transfer of pots and pans across the entire cooking surface.
- Sealed single piece tooled porcelainized cook top can hold more than a gallon of spills.
- Analog controls provide easy, push and turn operation.
- Blue light indicates oven functions.
- Heavy metal die-cast black satin knobs with chrome bezels.
- Stainless steel Island Back trim included and installed.

OVEN FEATURES

- Multiple functions include: Standard Bake, Convection Bake, Infrared Broil and Fan modes.
- Convection System optimizes uniform air flow.
- Two chrome plated heavy duty racks with 4 positions on heavy chrome side supports.
- Accommodates full size commercial sheet pan.
- Front panel switch controls oven lighting for optimal visibility.
- Oven front construction is a durable, precision-made one piece frame.

CONVECTION OVEN TECHNOLOGY



Balanced turbulent heat distribution is essential when baking, roasting, and dehydrating food. The American Range convection oven technology features a convection motor and louvered side panels to enhance uniform heat distribution throughout the large oven cavity.

The strategic placement of the convection fan ensures consistent heat distribution even when challenged with cooking the largest turkey, ham or roast.

CONVECTION OVEN IS GREEN TECHNOLOGY

The highly efficient design of the Convection Oven uses less gas versus a standard oven.

Customize with RAL® for the color that best suits your lifestyle.

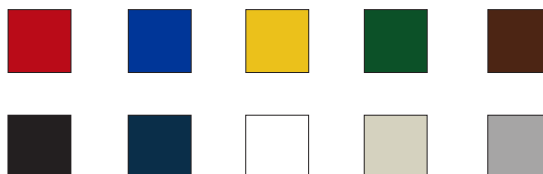

SCALE: NOT TO SCALE

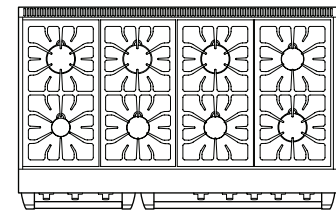
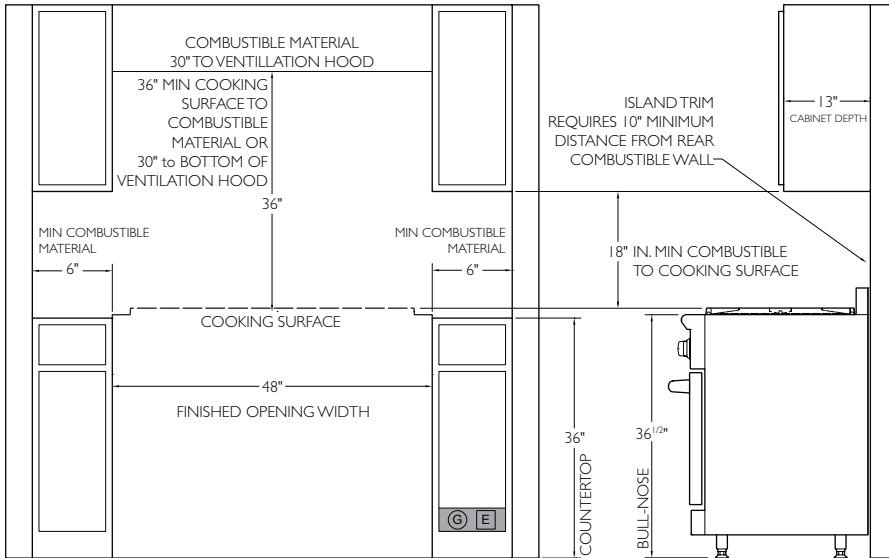
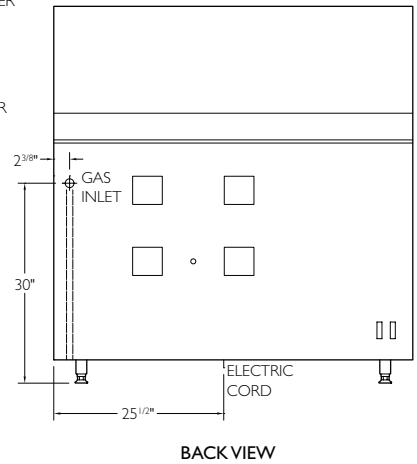
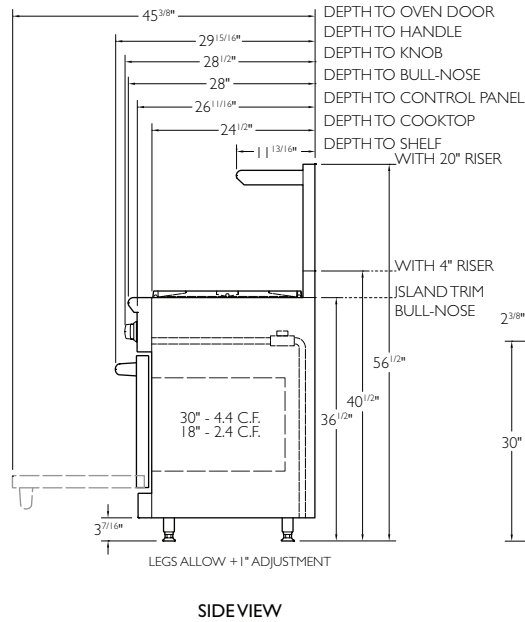
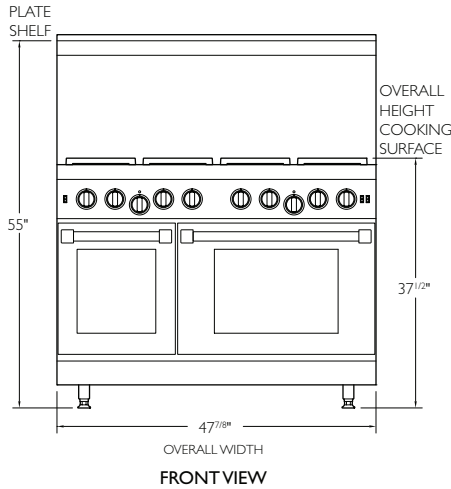

TOP VIEW

* ADJUSTABLE + 1"

A manual gas shut-off valve must be installed external to the appliance, in a location accessible from the front, for the purpose of shutting off the gas supply. This is a vented appliance. To be used in conjunction with a suitable vent hood only.

RECOMMENDED LOCATION OF GAS AND ELECTRICAL SUPPLY

ISLAND OR PENINSULA INSTALLATIONS 10" MINIMUM CLEARANCE FROM BACK OF RANGE TO COMBUSTIBLE SURFACE. ISLAND TRIM 0 IN. CLEARANCE TO NON COMBUSTIBLE SURFACE. NO SIDE WALL ABOVE COOKING SURFACE. THIS APPLIANCE SHOULD NOT BE INSTALLED WITH AN AIR CURTAIN OR OTHER TYPE OF VENTILATION SYSTEM THAT BLOWS AIR DOWNWARD TOWARD THE RANGE. SUCH TYPE OF VENTILATION SYSTEM MAY CAUSE IGNITION AND COMBUSTION PROBLEMS WITH THE GAS COOKING APPLIANCE RESULTING IN PERSONAL INJURY OR UNINTENDED OPERATION.

TECHNICAL SPECIFICATIONS

Overall Oven Capacity	2.4 CU. FT. (18" oven) - 4.4 CU. FT. (30" oven)	Total Gas Connection Rating per model #	ARR-848	172,000 BTU	8 burners
Oven Dimensions	14-1/2"W x 19" D x 15" H (18" oven) 26-1/2"W x 19" D x 15" H (30" oven)		ARR-648GD	162,000 BTU	6 burners & griddle
Surface Burner Rating	17,000 BTU (lg) - 13,000 BTU (md) - 9,000 BTU (sm)		ARR-648GR	160,000 BTU	6 burners & grill
Griddle Burner Rating	20,000 BTU for every 11" section		ARR-448GDGR	150,000 BTU	4 burners, griddle & grill
Grill Burner Rating	18,000 BTU for every 11" section	Gas Supply	ARR-4482GD	152,000 BTU	4 burners double griddle
Infrared Broiler	17,000 BTU each oven		ARR-448X2GR	148,000 BTU	4 burners double grill
Oven Bake Burner	28,000 BTU each oven	Electrical Supply	120 VAC 15 AMP 60 Hz Single Phase		
		Shipping Weight	660 Lbs		

ACCESSORIES AND OPTIONS

1" Island back (standard)	ARR48SIB-C	12" Grill Cover	ARRGRCOV12S-C	Extra Oven rack - 30" Oven	R31013	OPTIONS (FACTORY INSTALLED)	
1" Island back (welded)	ARR48IB-C	12" Griddle Plate	ARR-PGPI2-C	Easy Glide Rack 18"	ARR-SR-18-C	11" Chrome Flat Griddle Plate	MC11-FS-C
4" Stub Back	ARR484SB-C	24" Griddle Plate	ARRPGP24-C	Easy Glide Rack 30"	ARR-SR-30-C	11" Chrome Grooved Griddle Plate	MC11-GG-C
21" High back w/ Shelf	ARR4821HBS-C	24" Griddle Cover	ARRGDCCOV24S-C	Porcelainized Broiler Pan	R31005	22" Chrome Flat Finish Griddle Plate	MC22FSC
S/S Leg Caps (3)	ARR3LC-C	12" Cutting Board	ARRCUTB12-C			22" Cr L. Matte & R. Grooved GR Plate	MC22HGC
S/S Curb base	ARR48CB-C	Wok Adapter	ARRWOK-C			22" Chrome Flat Finish Griddle Plate	MC22FSC
12" Griddle Cover	ARRGDSCOVI2S-C	Extra Oven rack - 18" Oven	R31011			22" Griddle Plate w/ Flavor Separator	MC22-SP-C

**The American Range Company continually improves its products and reserves the right to change materials, specifications and dimensions without notice. This unit is manufactured for residential use only.

BURNER CONFIGURATIONS

● 17,000 BTU (lg)	● 13,000 BTU (md)	● 9,000 BTU (sm)
--	---	--

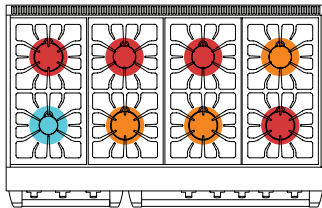

ARR-848

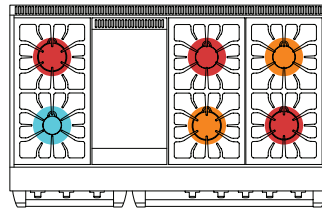

ARR-648GD

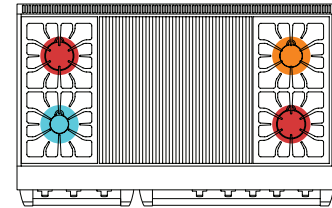

ARR-448X2GR

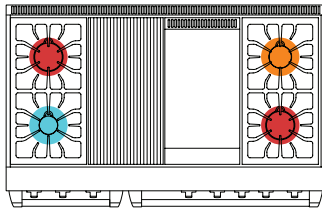

ARR-448GDGR

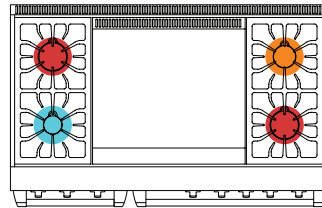

ARR-4482GD

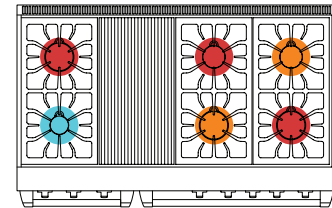

ARR-648GR

SCALE: NOT TO SCALE

MUST SHIP FROM FACTORY WITH PROPER GAS TYPE

N=Natural gas **L**= LP Gas. Must provide **N** or **L** after model number for type of gas needed. **Example: ARR-848-L.** Must specify elevation if over 2000 ft. when ordering.

*ELECTRICAL REQUIREMENTS

A grounded three prong plug with proper polarity must be used.